



: 013N1300

Unilift KP 350 M 1

1-

F,

, 10

10

: 0 .. 50 °C

998.2 / ³

: 10

DIN W.-Nr. 1.4301

AISI 304

DIN W.-Nr. 1.4031

AISI 304

:

:

Rp 1 1/4
: 7

:

- P1: 700

:

50 Hz

:

1 x 220-240

:

3.2 A

-

: 10 /400

(IEC 34-5):

IP68

(IEC 85):

F

:

10

:

SCHUKO

:

:

8

:

8.1

:

0.013 ³

1 Unilift KP 350 M 1



: 013N1300

1-

F,

, 10

10

: 0 .. 50 °C
 998.2 / 3

: 10

DIN W.-Nr. 1.4301
 AISI 304

DIN W.-Nr. 1.4031
 AISI 304

Rp 1 1/4
7

- P1: 700

50 Hz

1 x 220-240

3.2 A

10 /400

(IEC 34-5): IP68

(IEC 85): F

10

SCHUKO

8

8.1

0.013 ³

013N1300 Unilift KP 350 M 1 50

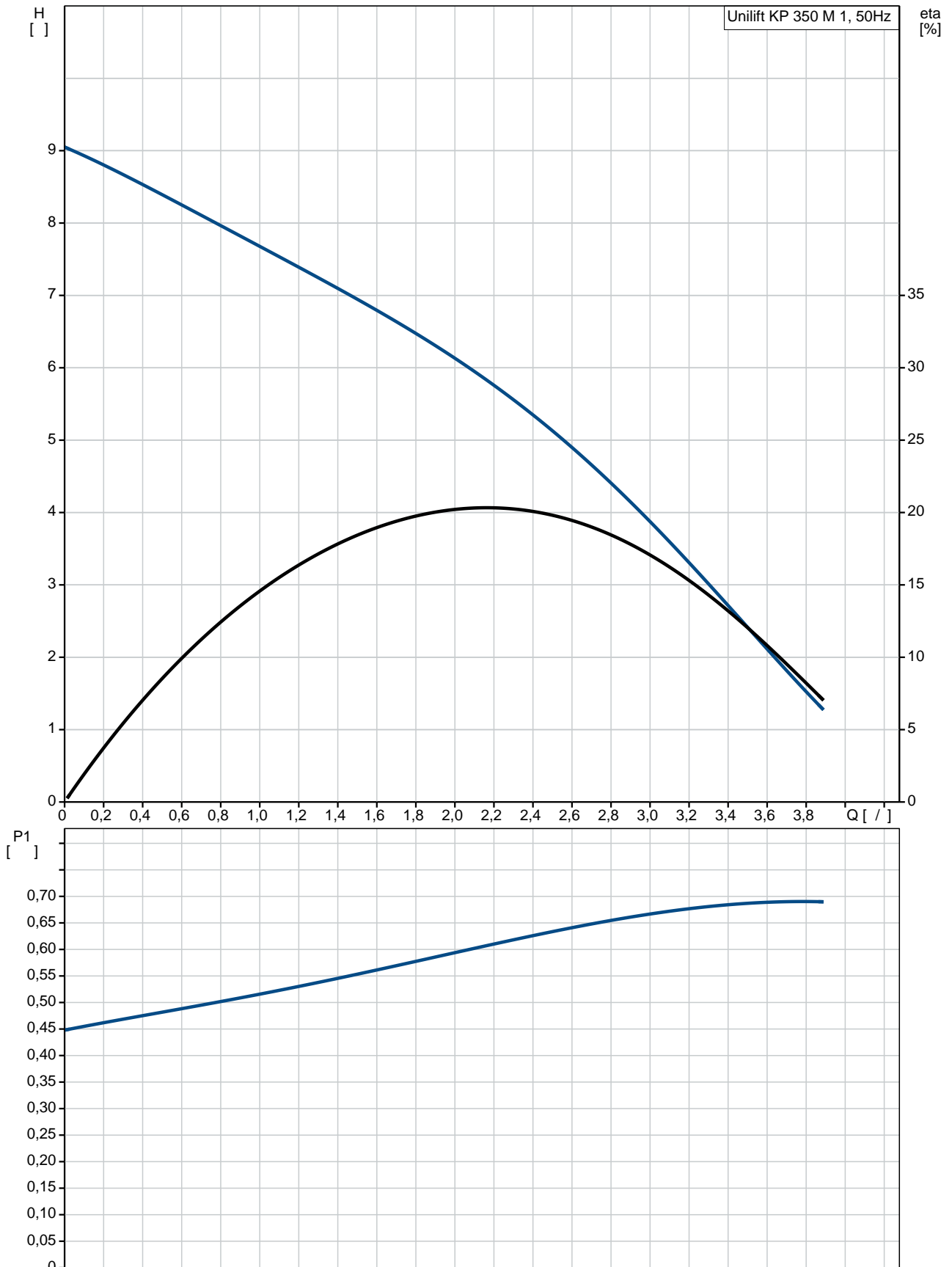

Unilift KP 350 M 1
 013N1300
 EAN : 5700393433182

Ma : 3.89 /
 : 9
 : 10
 : A

DIN W.-Nr. 1.4301
 AISI 304

DIN W.-Nr. 1.4031
 AISI 304

Rp 1 1/4
 7

0 .. 50 °C
 998.2 / ³

- P1: 700
 : 50 Hz
 : 1 x 220-240
 : 3.2 A
 : 10 /400
 (IEC 34-5): IP68
 (IEC 85): F
 : CONTACT

10
 SCHUKO

8
 8.1
 : 0.013 ³

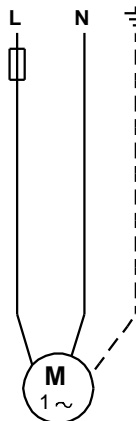
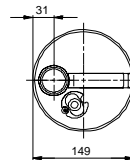
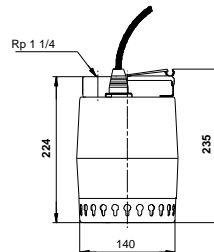
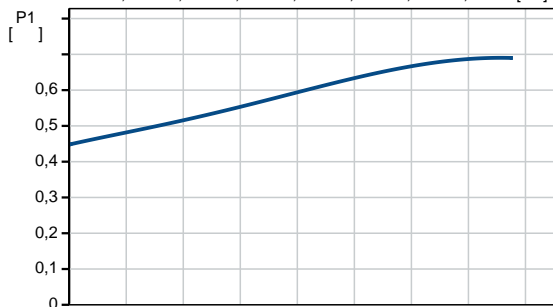
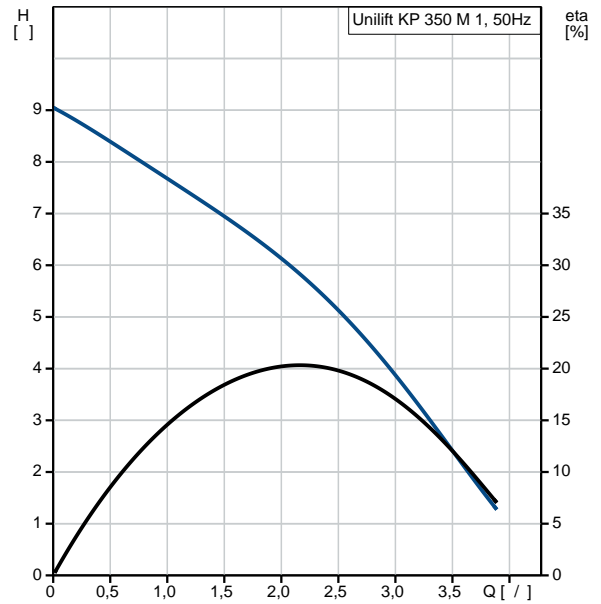

013N1300 Unilift KP 350 M 1 50

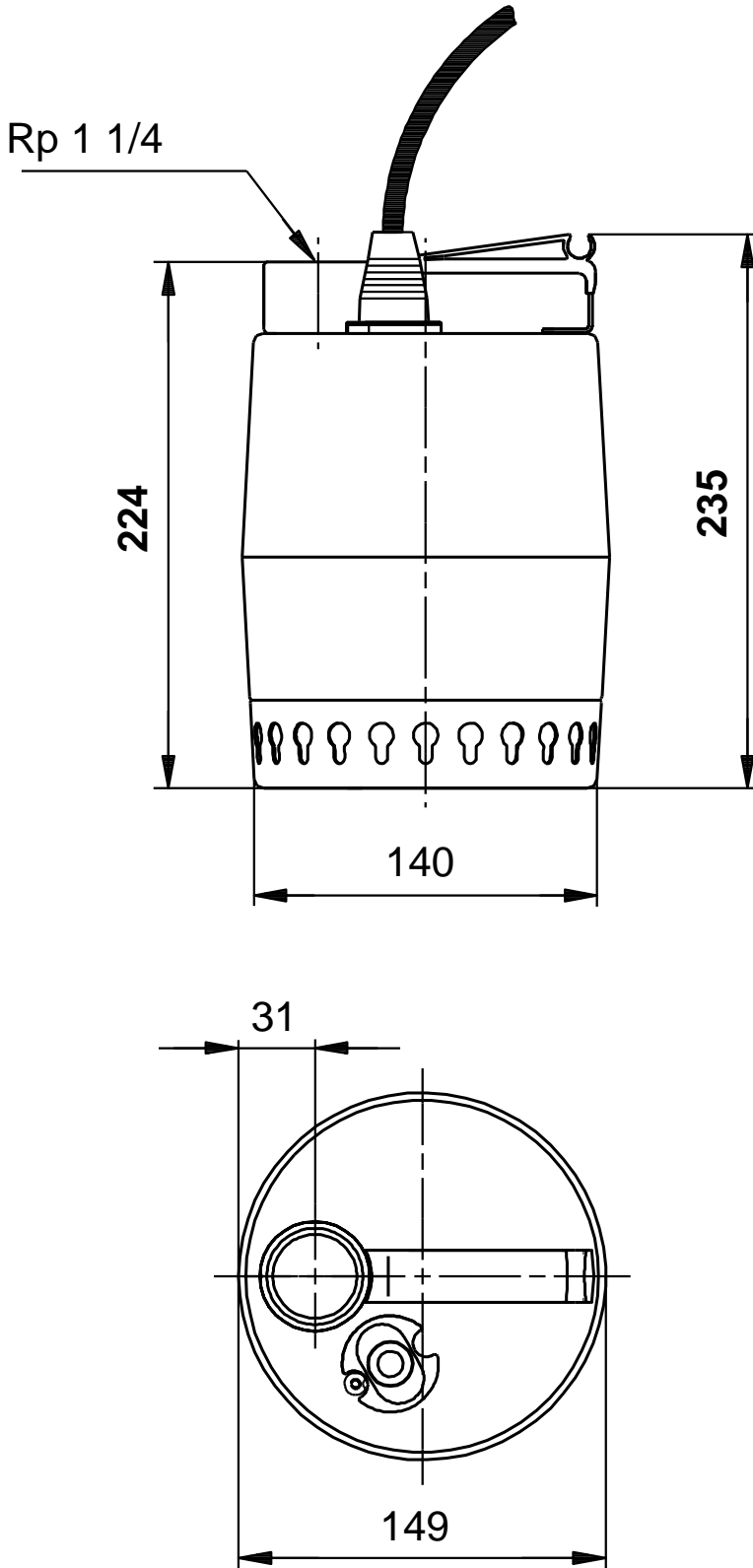

013N1300 Unilift KP 350 M 1 50

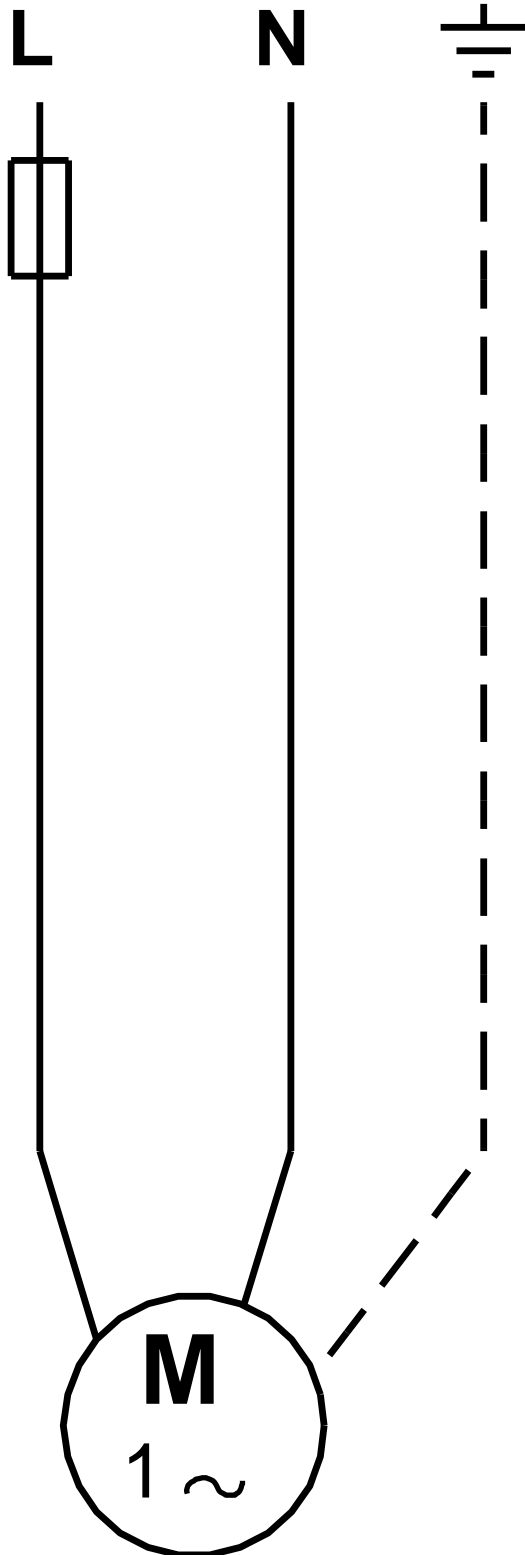

! [], .